

# Operating Instructions

**Radar sensor for continuous level measurement in plastic vessels**

## **VEGAPULS Air 23**

Autarkic device with measured value transmission via radio technology



Document ID: 64314



**VEGA**

# Contents

<b>1</b>	<b>About this document</b>	<b>4</b>
1.1	Function	4
1.2	Target group	4
1.3	Symbols used	4
<b>2</b>	<b>For your safety</b>	<b>5</b>
2.1	Authorised personnel	5
2.2	Appropriate use	5
2.3	Warning about incorrect use	5
2.4	General safety instructions	5
2.5	Lithium cells	6
2.6	Country of use	6
<b>3</b>	<b>Product description</b>	<b>7</b>
3.1	Configuration	7
3.2	Principle of operation	8
3.3	Adjustment	9
3.4	Packaging, transport and storage	9
3.5	Accessories	10
<b>4</b>	<b>Mounting</b>	<b>11</b>
4.1	General instructions	11
4.2	Mounting instructions	11
4.3	Mounting preparations	12
4.4	Installation procedure	13
4.5	Transportation lock after mounting	14
<b>5</b>	<b>Setup - the most important steps</b>	<b>15</b>
<b>6</b>	<b>Activate, device functions</b>	<b>17</b>
6.1	Activate	17
6.2	Measurement function, localization	19
<b>7</b>	<b>Transfer measured values and data to the cloud</b>	<b>20</b>
7.1	Communication basics	20
7.2	NB-IoT/LTE-M - VEGA Inventory System	20
7.3	LoRa-WAN (Fall back) - VEGA Inventory System	21
7.4	NB-IoT/LTE-M - VEGA Cloud	21
7.5	LoRaWAN - private networks	22
<b>8</b>	<b>Operate via VEGA Inventory System (mobile radio)</b>	<b>23</b>
<b>9</b>	<b>Diagnostics and servicing</b>	<b>24</b>
9.1	Maintenance	24
9.2	Rectify faults	24
9.3	How to proceed if a repair is necessary	25
<b>10</b>	<b>Removal with glue connection</b>	<b>26</b>
10.1	Dismounting instructions	26
10.2	Dismounting steps mounting ring	26
10.3	Disposal	27
<b>11</b>	<b>Certificates and approvals</b>	<b>28</b>

11.1	Radio licenses.....	28
11.2	EU conformity.....	28
11.3	Environment management system .....	28
<b>12</b>	<b>Supplement .....</b>	<b>29</b>
12.1	Technical data .....	29
12.2	Radio networks LTE-M and NB-IoT .....	32
12.3	Radio networks LoRaWAN - Data transmission .....	32
12.4	Dimensions .....	35
12.5	Industrial property rights.....	36
12.6	Licensing information for open source software .....	36
12.7	Trademark.....	36



**Safety instructions for Ex areas**

Take note of the Ex specific safety instructions for Ex applications. These instructions are attached as documents to each instrument with Ex approval and are part of the operating instructions.

Editing status: 2021-04-21

# 1 About this document

## 1.1 Function

This instruction provides all the information you need for mounting, connection and setup as well as important instructions for maintenance, fault rectification, the exchange of parts and the safety of the user. Please read this information before putting the instrument into operation and keep this manual accessible in the immediate vicinity of the device.

## 1.2 Target group

This operating instructions manual is directed to trained personnel. The contents of this manual must be made available to the qualified personnel and implemented.

## 1.3 Symbols used



### Document ID

This symbol on the front page of this instruction refers to the Document ID. By entering the Document ID on [www.vega.com](http://www.vega.com) you will reach the document download.



**Information, note, tip:** This symbol indicates helpful additional information and tips for successful work.



**Note:** This symbol indicates notes to prevent failures, malfunctions, damage to devices or plants.



**Caution:** Non-observance of the information marked with this symbol may result in personal injury.



**Warning:** Non-observance of the information marked with this symbol may result in serious or fatal personal injury.



**Danger:** Non-observance of the information marked with this symbol results in serious or fatal personal injury.



### Ex applications

This symbol indicates special instructions for Ex applications.



### List

The dot set in front indicates a list with no implied sequence.



### Sequence of actions

Numbers set in front indicate successive steps in a procedure.



### Battery disposal

This symbol indicates special information about the disposal of batteries and accumulators.

## 2 For your safety

### 2.1 Authorised personnel

All operations described in this documentation must be carried out only by trained, qualified personnel authorised by the plant operator.

During work on and with the device, the required personal protective equipment must always be worn.

### 2.2 Appropriate use

The VEGAPULS Air 23 is an autarkic sensor for continuous level measurement in plastic vessels.

You can find detailed information about the area of application in chapter " *Product description*".

Operational reliability is ensured only if the instrument is properly used according to the specifications in the operating instructions manual as well as possible supplementary instructions.

### 2.3 Warning about incorrect use

Inappropriate or incorrect use of this product can give rise to application-specific hazards, e.g. vessel overfill through incorrect mounting or adjustment. Damage to property and persons or environmental contamination can result. Also, the protective characteristics of the instrument can be impaired.

### 2.4 General safety instructions

This is a state-of-the-art instrument complying with all prevailing regulations and directives. The instrument must only be operated in a technically flawless and reliable condition. The operator is responsible for the trouble-free operation of the instrument. When measuring aggressive or corrosive media that can cause a dangerous situation if the instrument malfunctions, the operator has to implement suitable measures to make sure the instrument is functioning properly.

The safety instructions in this operating instructions manual, the national installation standards as well as the valid safety regulations and accident prevention rules must be observed by the user.

For safety and warranty reasons, any invasive work on the device beyond that described in the operating instructions manual may be carried out only by personnel authorised by the manufacturer. Arbitrary conversions or modifications are explicitly forbidden. For safety reasons, only the accessory specified by the manufacturer must be used.

To avoid any danger, the safety approval markings and safety tips on the device must also be observed.

The low transmitting power of the radar sensor as well as the integrated LTE-NB1, LTE-CAT-M1 or LoRa radio module is far below the internationally approved limits. No health impairments are to be expected with intended use. The band range of the transmission frequency can be found in chapter " *Technical data*".

## 2.5 Lithium cells

The power supply of the device is provided by integrated lithium cells in the housing. If the device is used as intended with the lid closed within the temperatures and pressures specified in the technical data, it is thus adequately protected.



**Note:**

Please observe the specific safety instructions in the scope of delivery of the device.

## 2.6 Country of use

Country-specific settings for transmission into the mobile radio network or LoRaWan are defined by selecting the country of use. It is absolutely essential to do this during the job-specific device configuration.



**Caution:**

Operation of the device with a false country of use selection can lead to malfunctions and constitutes a violation of the radio licensing regulations of the respective country.

## 3 Product description

### 3.1 Configuration

#### Scope of delivery

The scope of delivery encompasses:

- Radar sensor
- Integrated identification card for LTE (eSIM) (optional)
- Magnet for activation
- Mounting ring with glued surface, cleaning cloth (version for glued connection)
- Tension belt (for version with flexible changeable holder)
  
- Information sheet "*Documents and software*" with:
  - Instrument serial number
  - QR code with link for direct scanning
- Information sheet "*PINs and Codes*" with:
  - Identifier for LoRaWAN network (Device EUI, Application EUI, App Key)

The further scope of delivery encompasses:

- Documentation
  - Safety instructions for lithium metal cell
  - If necessary, further certificates

**Note:**

Optional instrument features are also described in this operating instructions manual. The respective scope of delivery results from the order specification.

#### Scope of this operating instructions

This operating instructions manual applies to the following instrument versions:

- Hardware version from 1.0.0
- Software version from 1.1.0

**Note:**

Details of the hardware and software history can be found on our homepage.

#### Versions

The radar sensor VEGAPULS Air 23 is available with different mounting techniques:

- Adhesive joint (antenna side)
- Flexibly exchangeable holder
- Ceil mounting

## Constituent parts

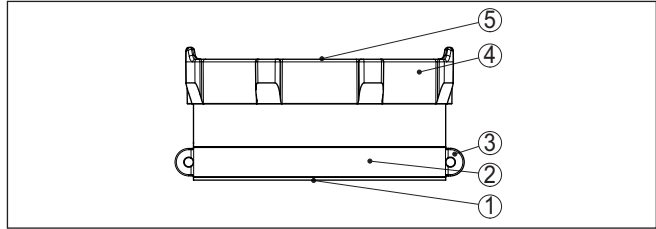

Fig. 1: Components of the VEGAPULS Air 23 sensor (example version for adhesive joint)

- 1 Radar antenna
- 2 Unscrewable mounting ring with glue surface
- 3 Eyelets for transport lock
- 4 Housing lid
- 5 Contact surface for activation by NFC or magnet

## Type label

The type plate contains the most important data for identification and use of the device. This is located on the sensor housing.

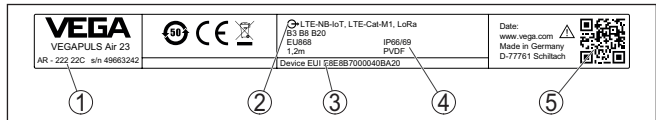

Fig. 2: Layout of the type label (example)

- 1 Order number
- 2 Wireless signal outputs, frequency bands
- 3 Device EUI LoRa
- 4 Technical data
- 5 QR code for device documentation

## 3.2 Principle of operation

### Application area

VEGAPULS Air 23 is a radar sensor for continuous level measurement of plastic vessels, e.g. IBC containers. <sup>1)</sup>

The device is suitable for almost all liquids.

Depending on the version, it is mounted to the vessel or to the ceiling by means of:

- Glue surface on the bottom side of the sensor (vessel mounting)
- Tension belt (vessel mounting)
- Mounting brackets on the housing (ceiling mounting)

### Functional principle

The instrument emits a continuous, frequency-modulated radar signal through its antenna. The emitted signal is reflected by the medium and received by the antenna as an echo with modified frequency. The frequency change is proportional to the distance and is converted into the level.

The measurement is made through the closed plastic ceiling of the vessel.

<sup>1)</sup> IBC = Intermediate Bulk Container



**Measured value transmission**

Depending on the availability of the radio networks, the device transmits its measured values wirelessly to an LTE-M (LTE-CAT-M1) or NB-IoT (LTE-CAT-NB1) mobile radio or a plant-side LoRaWAN network.

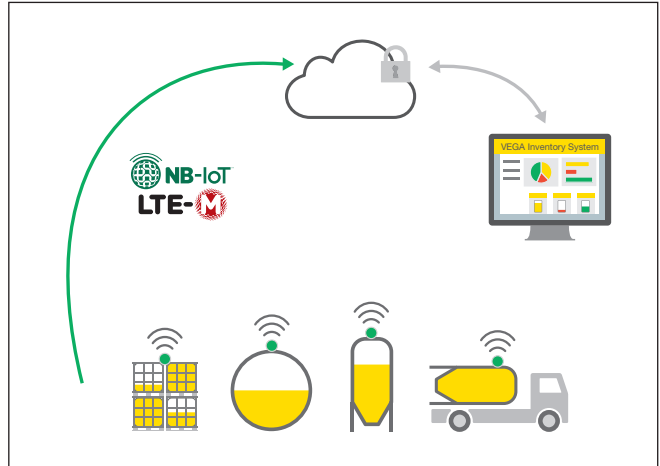

Fig. 3: Wireless measured value transmission via mobile radio

The transmission or evaluation is carried out via an Asset Management System, e.g. VEGA Inventory System.

**Voltage supply**

The device is supplied with energy by non-exchangeable primary cells. The lithium cell used for this purpose is a compact storage device with high cell voltage and capacity for a long service life.

**3.3 Adjustment**

The device is activated contactlessly from outside:

- Via magnet
- By NFC technology via smartphone/tablet with VEGA Tools app

There are no additional adjustment options.

**3.4 Packaging, transport and storage**

**Packaging**

Your instrument was protected by packaging during transport. Its capacity to handle normal loads during transport is assured by a test based on ISO 4180.

The packaging consists of environment-friendly, recyclable cardboard. For special versions, PE foam or PE foil is also used. Dispose of the packaging material via specialised recycling companies.

**Transport**

Transport must be carried out in due consideration of the notes on the transport packaging. Nonobservance of these instructions can cause damage to the device.

<b>Transport inspection</b>	The delivery must be checked for completeness and possible transit damage immediately at receipt. Ascertained transit damage or concealed defects must be appropriately dealt with.
<b>Storage</b>	<p>Up to the time of installation, the packages must be left closed and stored according to the orientation and storage markings on the outside.</p> <p>Unless otherwise indicated, the packages must be stored only under the following conditions:</p> <ul style="list-style-type: none"> <li>● Not in the open</li> <li>● Dry and dust free</li> <li>● Not exposed to corrosive media</li> <li>● Protected against solar radiation</li> <li>● Avoiding mechanical shock and vibration</li> </ul>
<b>Storage and transport temperature</b>	<ul style="list-style-type: none"> <li>● Storage and transport temperature see chapter " <i>Supplement - Technical data - Ambient conditions</i> "</li> <li>● Relative humidity 20 ... 85 %</li> </ul>

### 3.5 Accessories

<b>LoRa-Gateway</b>	<p>The LoRa gateway receives via LoRaWAN the measurement and diagnosis data of appropriately configured VEGA LoRaWAN sensors. The gateway combines the received data and transmits them via mobile network to the VEGA Inventory System.</p> <p>The measured values and messages are transmitted via the GSM/GPRS/UMTS/LTE network.</p>
<b>VEGA Inventory System</b>	<p>VEGA Inventory System is a web-based software for simple recording, presentation and further processing of measured values. The measured values can be transmitted via network, internet or mobile network to the central server.</p>

## 4 Mounting

### 4.1 General instructions

#### Ambient conditions

The instrument is suitable for standard and extended ambient conditions acc. to DIN/EN/IEC/ANSI/ISA/UL/CSA 61010-1. It can be used indoors as well as outdoors.

#### Process conditions

**Note:**

For safety reasons, the instrument must only be operated within the permissible process conditions. You can find detailed information on the process conditions in chapter " *Technical data*" of the operating instructions or on the type label.

Hence make sure before mounting that all parts of the instrument exposed to the process are suitable for the existing process conditions.

#### Measurement function and transport

An activated device (see chapter " *Activate device*") also carries out measurements in horizontal alignment. This also applies if it is mounted on a mobile container and the container is transported in a tilted state.

**Note:**

When mounting the device in a mobile container, ensure that it is protected against damage throughout transport.

### 4.2 Mounting instructions

#### Container requirements

The containers can be commercially available combination IBC containers with a nominal volume of e.g. 1000 l. These typically consist of an inner container made of HDPE, a metal outer cage and a pallet.



Fig. 4: IBC container - Example

**Installation position**

The device can only be mounted on the top of an IBC container in one of the areas shown below:

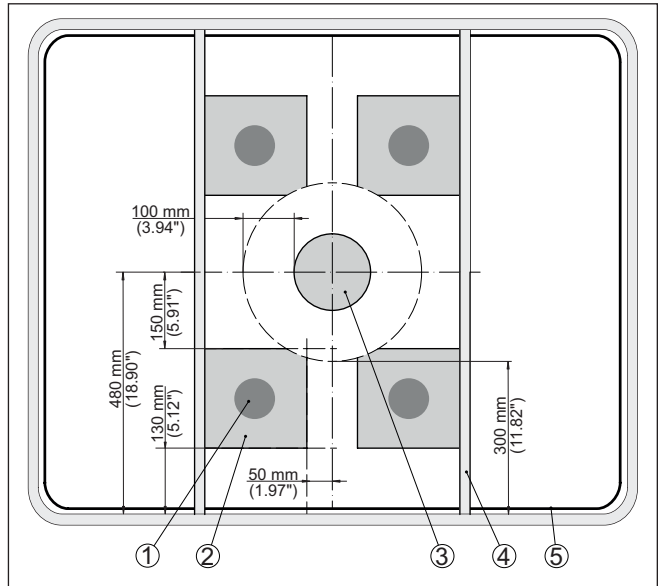

Fig. 5: Mounting position on the tank ceiling

- 1 Recommended mounting position
- 2 Permissible mounting range
- 3 Filling opening
- 4 Cross strut
- 5 Vessel edge

To avoid air bubbles in the area of the adhesive surface, the selected mounting position should be as flat as possible or slightly curved outwards.

**Note:**

Mounting positions or vessel ceilings with an inwardly curved surface are not suitable for fastening.

**4.3 Mounting preparations****Mounting preparation adhesive joint**

The intended mounting position must be dry and free of dust, oil and grease before mounting the sensor.

**Note:**

For this reason, clean the container ceiling in particular with the isopropanol-based cleaning cloth supplied. After cleaning the surface, first allow it to flash off well so that any residual solvent can evaporate.

**Warning:**

The 2-propanol contained in the cleaning cloth is highly flammable and harmful to health. Observe the hazard warnings on the packaging and the safety data sheet on our homepage.



**Caution:**

The cleaning cloth supplied must not be used for chemical residues on the surface. Ask the chemical manufacturer for cleaning options. It is not possible to mount the sensor on a surface that has not been cleaned.

**4.4 Installation procedure**

**Glued connection**

The device version for adhesive bonding has a mounting ring with adhesive surface on the lower side of the housing.

Proceed as follows:

1. Completely remove the protective foil on the glue surface immediately before mounting
2. Position the sensor on the pre-cleaned area in one operation and press on firmly for approx. 30 s

The glue surface bonds adhesively to the surface of the IBC container and reaches its final adhesive strength after approx. 72 hours. A correction of the sensor position is no longer possible once the adhesive tape has been pressed.



**Note:**

The adhesive strength is considerably reduced after removal. If the sensor position is subsequently changed, a new adhesive tape must be applied. Please contact your contact person at VEGA.



**Danger:**

Re-applying the sensor with adhesive tape that is not as good as new means that there is a risk of uncontrolled loosening of the device. This can endanger, injure or damage people, animals and property (especially during transport).

**Flexibly exchangeable holder**

The device version with flexibly exchangeable holder is attached to the vessel via the tension belt.

To prevent the device from slipping out of its mounting position, it has a foam pad on the bottom side.

For mounting proceed as follows:

1. Loop the tension belt into the cross struts of the IBC container
2. Insert belt into guides on the housing cover, close click connection
3. Slide sensor into mounting position
4. Tighten belt, check sensor for secure fit



**Note:**

Ensure direct, permanent contact between the bottom of the sensor and the surface of the IBC container.

**Ceil mounting**

The device version for ceiling mounting has mounting brackets on the housing cover. The mounting is carried out using suitable screws and dowels provided by the customer.

**Transportation lock****4.5 Transportation lock after mounting**



The adhesive joint and the flexible mounting of the device are only designed for stationary operation of the vessel.

**Danger:**



During transport the vessel is exposed to vibrations and shocks. This can cause the device to fall down with the risk of damage to property or persons. To avoid this, the device must be additionally secured using the integrated safety eyelets on the vessel, e.g. with a metal wire.

## 5 Setup - the most important steps



### Prerequisites

What?	How?
Account in the VEGA Inventory System 	Available from your VEGA contact person
User role supervisor 	Is assigned by your VEGA Inventory System administrator
VEGA Tools app, VEGA Inventory System app 	Download via Apple App Store, Google Play Store, Baidu Store



### Activate the sensor

Via magnet	Via smartphone (VEGA Tools app or VEGA Inventory System app)
Move the supplied magnet along the line towards the housing lid 	Call up NFC communication, hold the smartphone close to the side of the device with the lettering "VEGA" 

### Set up measuring point in the VEGA Inventory System

Web portal	VEGA Inventory System app
	
Menu item "Device networks - Add" - Enter serial number and device name	Menu item "Add device" - Scan QR code on device or enter serial number manually

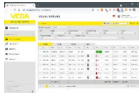
**Configure sensor**

<p><b>Web portal</b></p> 	<p><b>VEGA Inventory System app</b></p> 
<p>Menu item " <i>Adjustment/linearization</i>" - Open assistant (measuring range and transmission interval via VEGA Tools app)</p>	<p>Complete wizard with Linearisation/adjustment</p>



## 6 Activate, device functions

### 6.1 Activate

#### Activate device - Overview

The following options are available for activating the device from the deactivated delivery status:

- By smartphone with VEGA Tools app via NFC
- Via magnet

It is not necessary to open the device for activation.



#### Note:

The device is intended for permanent use. Deactivation is therefore only possible by service intervention in the power supply. Please take this into account before activation!

#### Activate device - glue mounting

#### By smartphone

Proceed as follows for activation by smartphone:

1. Start VEGA Tools app on smartphone
2. Activate NFC communication
3. Hold the operating tool in the centre, close to the top of the instrument, above the lettering "VEGA"

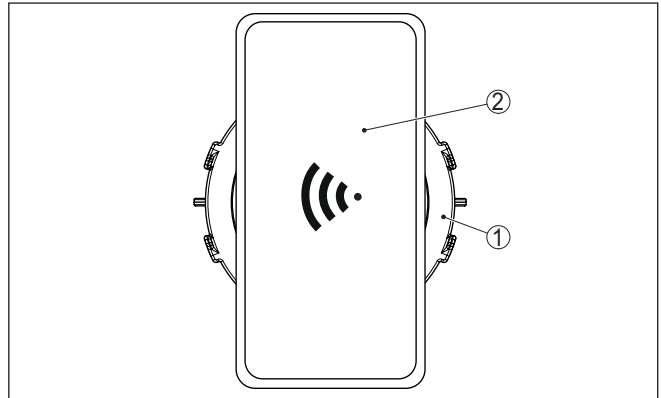

Fig. 6: Activate sensor - Smartphone

- 1 Radar sensor
- 2 Contact surface for NFC communication
- 3 Adjustment tool, e.g. smartphone

The app confirms successful activation, setup is complete and the device goes into operation.

#### Via magnet

Proceed as follows for activation by magnet:

- Hold the magnet close to the upper side of the instrument next to the lettering "VEGA" and move it once around in a circle.

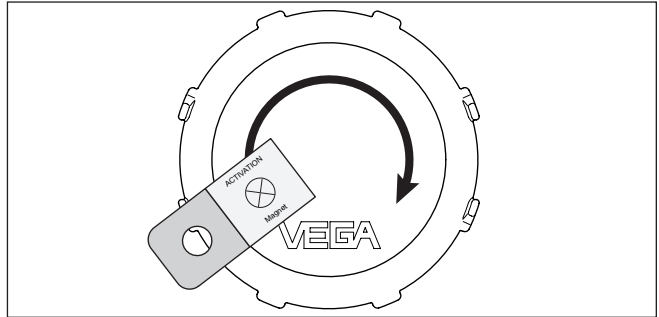

Fig. 7: Activate sensor - Magnet

- 1 Radar sensor
- 2 Contact surface for magnet
- 3 Magnet

Setup is now complete and the unit is ready for operation.

### Activate device - Ceiling mounting



#### Note:

Devices for ceiling mounting must be activated in advance of installation.

#### By smartphone

Proceed as follows for activation by smartphone:

1. Start VEGA Tools app on smartphone
2. Activate NFC communication
3. Hold the operating tool in the centre, close to the top of the instrument, above the lettering "VEGA"

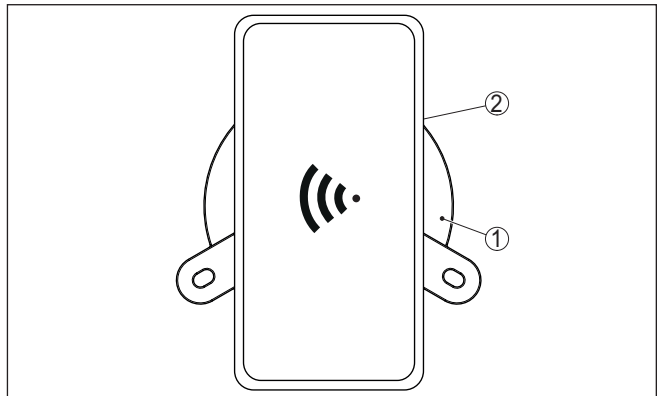

Fig. 8: Activate sensor - Smartphone

- 1 Radar sensor
- 2 Contact surface for NFC communication
- 3 Adjustment tool, e.g. smartphone

The app confirms successful activation, setup is complete and the device goes into operation.

**Via magnet**

Proceed as follows for activation by magnet:

→ Hold the magnet close to the upper side of the instrument next to the lettering "VEGA" and move it once around in a circle.

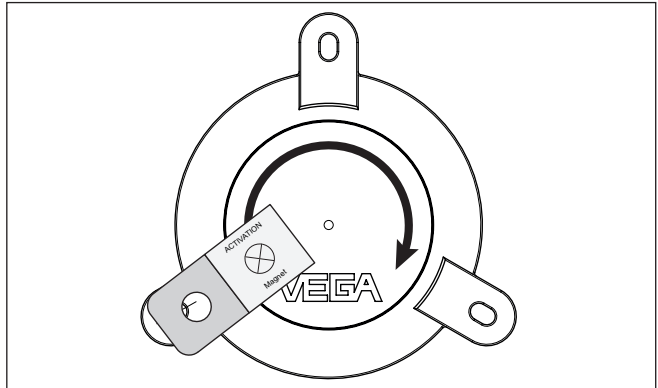

Fig. 9: Activate sensor - Magnet

- 1 Radar sensor
- 2 Contact surface for magnet
- 3 Magnet

Setup is now complete and the unit is ready for operation.

**6.2 Measurement function, localization**

**Measured value transmission**

After activation, a single measurement is carried out and the cyclic measurement interval is started. The sensor delivers the distance value from the bottom of the antenna to the medium surface. The conversion into level is carried out e.g. in the VEGA Inventory System on the application server or in a cloud service.

**Single measurement**

The device offers the possibility to test the communication in the respective network. The current measured value is determined and transmitted once outside the cyclical transmission.

The procedure is done by new activation via NFC or magnet as described above. The sensor is simultaneously activated for the cyclical transmission of measured values. The transmission cycle of an already activated sensor is not changed by this.

**Localization**

The geographical position is determined by a GNSS sensor integrated into the LTE-M/NB-IoT version of the device via navigation satellites.<sup>2)</sup>

With activated position determination, a GPS position determination is performed once during a mobile radio cell change. If no position was found after 300 sec., the position determination will be interrupted and will only be carried out after a new cell change.

<sup>2)</sup> No position determination in LoRa mode

## 7 Transfer measured values and data to the cloud

### 7.1 Communication basics

To transmit the measured values and data to the cloud, the device requires access to mobile network or a LoRaWAN network at the installation site, depending on the version. If no corresponding network is available, a LoRaWAN gateway must be installed.



#### Note:

Ensure free access to the radio network. The device must not be covered by metal or even enclosed. This especially for the medium height of the housing.



#### Note:

Simultaneous operation of LTE-M or LTE-IoT and LoRaWAN is not supported.

The following measured values or data are transmitted:

- Distance from the medium surface (m)
- Electronic temperature (°C)
- Geographical position determined by GNSS (geographical coordinates)
- Mounting position (angle °)
- Remaining life of Lithium cells (%)
- Device status

The transmission options are described below.

### 7.2 NB-IoT/LTE-M - VEGA Inventory System

With NB-IoT (Narrow band Internet of Things) and LTE-M (Long Term Evolution for Machines), the focus is on low data rates and high transmission ranges. Another focus is on penetrating propagation obstacles, such as buildings, for which the long-wave signal is well suited.

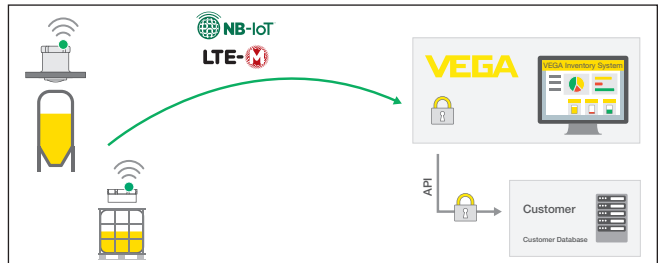

Fig. 10: Wireless measured value transmission via NB-IoT and LTE-M to the VEGA Inventory System

Data is sent via an eSIM card integrated in the sensor. This card sends the data via mobile network directly to the VEGA Inventory System. If no mobile network is available, a fallback to LoRa takes place automatically (see below).

After data transmission via the mobile network, the sensors are automatically made known in the VEGA Inventory System via their serial number. As soon as the sensors are integrated there, the data are available for visualisation.

### 7.3 LoRa-WAN (Fall back) - VEGA Inventory System

LoRaWAN (Long Range Wide Area Network) is the data transmission mode that is available when the mobile network fails. However, this requires a corresponding gateway. This gateway picks up the data via LoRa from the sensors and transmits them via mobile radio to VEGA's own LoRa server.

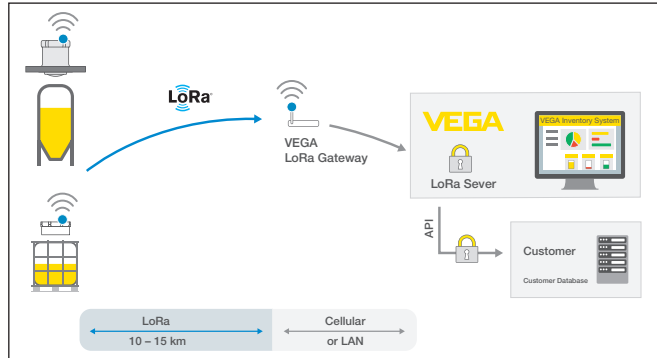

Fig. 11: Wireless measured value transmission via LoRa-WAN, LoRa server to the VEGA Inventory System

Both the end devices and the gateways are stored there with their data. The sensors and gateways have so-called Device EUIs via which they can be clearly identified. The LoRa server then transmits the data to the VEGA Inventory System.

### 7.4 NB-IoT/LTE-M - VEGA Cloud

Data is sent via an eSIM card integrated in the sensor. This card sends the data via the mobile network directly to the VEGA cloud.

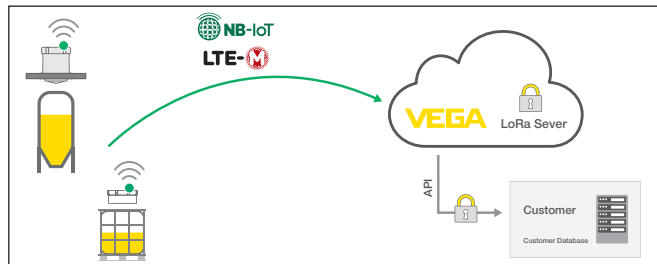

Fig. 12: Wireless measured value transmission via NB-IoT and LTE-M to the VEGA cloud

## 7.5 LoRaWAN - private networks

Another possibility is to send the data via the user's private LoRa WAN network. In this case, the sensor must be made known in this network.

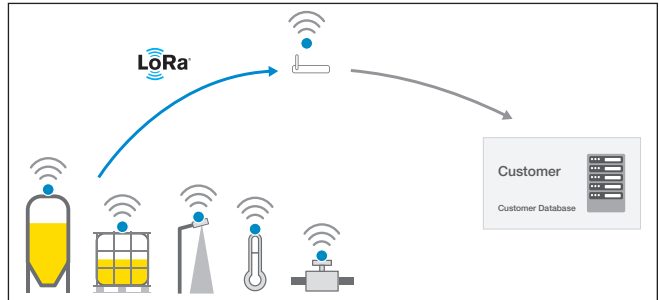

Fig. 13: Wireless measured value transmission

To do this, the user creates the sensor in his interface with its identification values (DevEUI, AppKey and JoinEUI). After a "Join" has been triggered, the sensor appears in the user interface. The payload - i.e. the transmitted bytes - are described in chapter "Radio network LoRaWAN - data transmission" and are decoded accordingly in the application system.

## 8 Operate via VEGA Inventory System (mobile radio)

### Overview

The VEGA Inventory System offers the possibility to change parameters in VEGAPULS Air 23 by remote access via mobile radio (feedback channel).

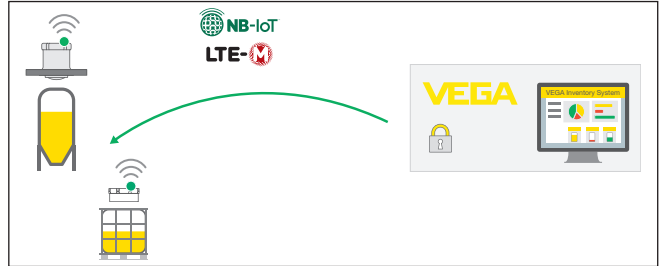

Fig. 14: Remote access from VEGA Inventory System via NB-IoT or LTE-M to the sensor



### Note:

This remote access is not supported when connecting via LoRaWAN.

### Prerequisites

Prerequisites for the use of this feedback channel are:

- Device software from 1.1.0<sup>3)</sup>
- Current version of the VEGA Inventory Systems
- Available mobile connection via NB-IoT/LTE-M

### Adjustment volume

The following parameters can be changed:

- Measuring range begin/measuring range end
- Measuring and transmission interval

In addition, the following actions can be triggered:

- Localization

The changes are first stored in the VEGA Inventory System. They are transferred to the sensor with the next cyclical measured value transmission and are then effective.



### Note:

If parameterization protection is activated in the sensor, this remote access is not available.

<sup>3)</sup> Devices with this software version or higher have a suitable mobile radio chip. A software update to this version is not possible.

## 9 Diagnostics and servicing

### 9.1 Maintenance

#### Maintenance

If the device is used properly, no special maintenance is required in normal operation.

#### Cleaning

The cleaning helps that the type label and markings on the instrument are visible.

Take note of the following:

- Only use cleaning agents that do not attack the housing, type plate, seals and the glue connection to the vessel
- Use only cleaning methods corresponding to the housing protection rating
- Keep a distance of at least 0.5 m when using high-pressure cleaners



#### Caution:

Mounting with tension belt is generally not suitable for high pressure cleaning. In case of insufficient fixation, the device may come loose from the holder depending on the pressure and distance. This can result in personal injury and damage to property. To avoid this, remove the unit from the vessel before cleaning.

### 9.2 Rectify faults

#### Reaction when malfunction occurs

The operator of the system is responsible for taking suitable measures to rectify faults.

#### Causes of malfunction

The device offers maximum reliability. Nevertheless, faults can occur during operation. These may be caused by the following, e.g.:

- Sensor
- Process
- Charge state of the lithium cell
- Availability/quality of radio transmission
- Signal processing

#### Reaction after fault rectification

Depending on the reason for the fault and the measures taken, the steps described in chapter "Setup" must be carried out again or must be checked for plausibility and completeness.

#### 24 hour service hotline

Should these measures not be successful, please call in urgent cases the VEGA service hotline under the phone no. **+49 1805 858550**.

The hotline is also available outside normal working hours, seven days a week around the clock.

Since we offer this service worldwide, the support is provided in English. The service itself is free of charge, the only costs involved are the normal call charges.



### 9.3 How to proceed if a repair is necessary

You can find an instrument return form as well as detailed information about the procedure in the download area of our homepage. By doing this you help us carry out the repair quickly and without having to call back for needed information.

In case of repair, proceed as follows:

- Print and fill out one form per instrument
- Clean the instrument and pack it damage-proof
- Attach the completed form and, if need be, also a safety data sheet outside on the packaging
- Ask the agency serving you to get the address for the return shipment. You can find the agency on our homepage.

## 10 Removal with glue connection

### 10.1 Dismounting instructions

The device can be removed from the surface of an IBC container by unscrewing the sensor housing from the mounting ring. The mounting ring with its adhesive connection remains on the surface of the vessel and can be used for remounting the sensor.

If the mounting ring should be removed, follow the mounting steps in the next section.

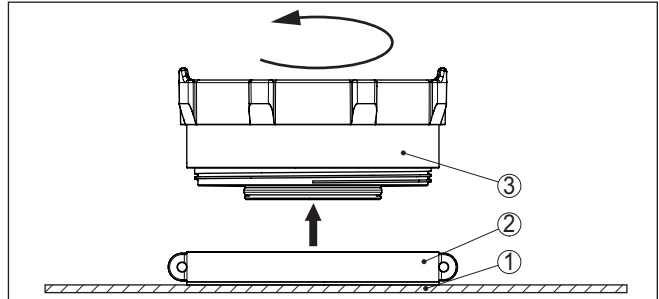

Fig. 15: Removal with glue connection

- 1 Vessel top
- 2 Mounting ring with glue surface
- 3 Sensor



#### Danger:

If the sensor shows obvious damage, there is a risk of ignition due to a possibly damaged Lithium cell. In this case, the device must not be packed or transported any further.

### 10.2 Dismounting steps mounting ring

#### Tool

The following tools are required to remove the mounting ring:

- Strap wrench
- if necessary a wooden scraper



#### Danger:

Depending on the medium in the IBC container, damage to the container may pose further risks for the user, the effects of which cannot be foreseen. Therefore, inform yourself about the contents of the IBC container before starting dismantling work and follow the instructions of the safety data sheet for the medium.



#### Caution:

The use of pointed or levering tools for dismantling may result in damage to the IBC container or equipment with the consequences shown above. Therefore, follow the procedure described below and use only tools recommended by VEGA.

#### Dismount

Proceed as follows while dismantling:

1. Place strap wrench around the mounting ring
2. Twist the mounting ring with the strap wrench, the adhesive bond is dissolved without any major force application.
3. Remove adhesive residues completely using a wooden scraper and dispose of in accordance with local regulations

**Tip:**

If the mounting ring is to be used again, the adhesive ring is available from VEGA as a spare part.

### 10.3 Disposal

The device is made of recyclable materials. For this reason, it should be disposed of by a specialist recycling company. Observe the applicable national regulations.

#### Battery/accumulator recycling

**Note:**

The disposal is subject to the EU directive on batteries and accumulators.

Batteries and accumulators contain some environmentally harmful but also some valuable raw materials that can be recycled. For that reason batteries and accumulators must not be disposed of in household waste.

All users are legally obligated to bring spent batteries to a suitable collection point, e.g. public collection points. You can also return the batteries and accumulators to us for correct disposal. Due to the very strict transport regulations for lithium-based batteries/accumulators, this is normally not a good idea because shipment is very expensive.

If you have no way to dispose of the old instrument properly, please contact us concerning return and disposal.

## 11 Certificates and approvals

### 11.1 Radio licenses

#### **Radar**

The device has been tested and approved in accordance with the current edition of the applicable country-specific norms or standards.

Regulations for use can be found in the document "*Regulations for radar level measuring instruments with radio licenses*" on our homepage.

### 11.2 EU conformity

The device fulfils the legal requirements of the applicable EU directives. By affixing the CE marking, we confirm the conformity of the instrument with these directives.

The EU conformity declaration can be found on our homepage.

### 11.3 Environment management system

Protection of the environment is one of our most important duties. That is why we have introduced an environment management system with the goal of continuously improving company environmental protection. The environment management system is certified according to DIN EN ISO 14001. Please help us fulfil this obligation by observing the environmental instructions in chapters "*Packaging, transport and storage*", "*Disposal*" of these operating instructions.

## 12 Supplement

### 12.1 Technical data

#### Note for approved instruments

The technical data in the respective safety instructions which are included in delivery are valid for approved instruments (e.g. with Ex approval). These data can differ from the data listed herein, for example regarding the process conditions or the voltage supply.

All approval documents can be downloaded from our homepage.

#### Materials and weights

##### Materials, non-wetted parts

- |  |          |
|--|----------|
| – Housing  | PVDF     |
| – Mounting ring  | HDPE     |
| – Foam material on mounting ring with flexibly exchangeable holder | EPDM     |
| – Cover gasket   | Silicone |

Weight, depending on the version

- |                                     |                             |
|-------------------------------------|-----------------------------|
| – Glue connection, ceiling mounting | approx. 0.35 kg (0.772 lbs) |
| – Flexibly exchangeable holder      | approx. 0.55 kg (1.212 lbs) |

#### Input variable

Measured variable	The measured variable is the distance between the antenna edge of the sensor and the medium surface. The antenna edge is also the reference plane for the measurement.
-------------------	--

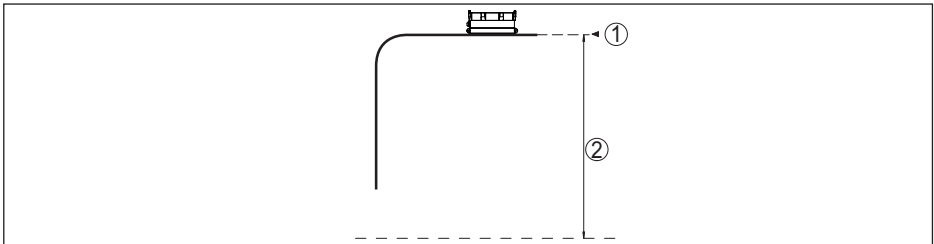

Fig. 16: Data of the input variable

- 1 Reference plane
- 2 Measured variable, max. measuring range

Max. measuring range	3 m (9.84 ft)
----------------------	---------------

#### Deviation (according to DIN EN 60770-1)

Process reference conditions according to DIN EN 61298-1

- |                     |   |
|---------------------|---|
| – Temperature       | +18 ... +30 °C (+64 ... +86 °F)                       |
| – Relative humidity | 45 ... 75 %   |
| – Air pressure      | 860 ... 1060 mbar/86 ... 106 kPa (12.5 ... 15.4 psig) |

## Installation reference conditions

- Distance to installations > 200 mm (7.874 in)
- Reflector Flat plate reflector
- False reflections Biggest false signal, 20 dB smaller than the useful signal

## Deviation

See following graphic:

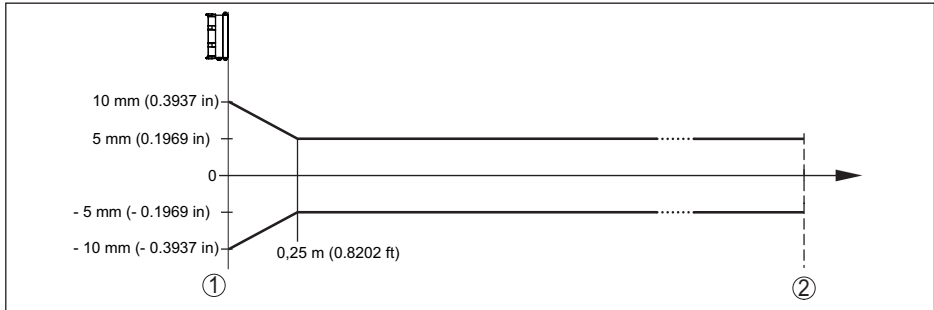

Fig. 17: Deviation under reference conditions

1 Reference plane

2 Recommended measuring range

---

**Characteristics and performance data**

---

Measuring frequency	W-band (80 GHz technology)
Measuring cycle time	≤ 5 s
Measuring and transmission interval	every 15 minutes ... every 24 hours (configurable on ordering)
Beam angle <sup>4)</sup>	8°
Emitted HF power (depending on the parameter setting) <sup>5)</sup>	
- Average spectral transmission power density	-86.2 dBm/MHz EIRP
- Max. spectral transmission power density	< 34 dBm/50 MHz EIRP
- Max. power density at a distance of 1 m	< 0.3 μW/cm <sup>2</sup>
Alignment for measurement	vertical 90°, ± 10°

---

**Switch-on phase**

---

Start-up time to the first valid measured value	< 10 s
---	--------

<sup>4)</sup> Outside the specified beam angle, the energy level of the radar signal is 50% (-3 dB) less.

<sup>5)</sup> EIRP: Equivalent Isotropic Radiated Power

---

**Wireless data transmission**

---

Frequency bands <sup>6)</sup>

- NB-IoT (LTE-Cat-NB1)	B1, B2, B3, B4, B5, B6, B8, B12, B13, B17, B19, B20, B25, B26, B28, B66
- LTE-M (LTE-CAT-M1)	B1, B2, B3, B4, B5, B6, B8, B12, B13, B14, B17, B18, B19, B20, B25, B26, B28, B66
- LoRaWAN	EUR868, US915, AS923

---

**Ambient conditions**

---

Ambient temperature	-20 ... +60 °C (-4 ... +140 °F)
Storage and transport temperature	-20 ... +80 °C (-4 ... +176 °F)

---

**Mechanical environmental conditions**

---

Sinusoidal vibrations	Class 5M2 acc. to IEC 60271-3-5
Impacts	10 g, 11 ms; 30 g, 6 ms acc. to IEC 60271-3-5 (mechanical shock)
Impact resistance	IK07 acc. to IEC 62262 <sup>7)</sup>

---

**Process conditions**

---

Process temperature	-20 ... +60 °C (-4 ... +140 °F)
---------------------	---------------------------------

---

**Integrated clock**

---

Date format	Day.Month.Year
Time format	12 h/24 h
Time zone, factory setting	CET
Max. rate deviation	10.5 min/year

---

**Integrated primary cell**

---

Cell type	LS 17500, Lithium metal (Li/SOCL <sub>2</sub> ), not rechargeable
Number of single cells	2
Cell voltage, each	3.6 V
Cell capacitance, each	3.6 Ah
Energy content, each	12.96 Wh
Lithium content, each	approx. 0.9 g
Weight, per typ.	23 g
Self-discharge	< 1 % after 1 year at 20 °C

Running time - detailed data on the running time is supplied by the calculation tool on our homepage <sup>8)</sup>

<sup>6)</sup> Delivery country-specific according to order configuration

<sup>7)</sup> Testing with hemisphere 50 mm, 500 g, ±25 g

<sup>8)</sup> Specifications apply to this cell type at approx. +25 °C (+77 °F) ambient temperature and strong reception signal (mobile radio/LoRa). Actual running time may vary greatly depending on the network provider, temperature or humidity. Small measuring intervals generally shorten the running time.

Interval	LoRaWAN	NB-IoT/LTE-M
0.25 h	> 1.5 years	< 0.5 years <sup>9)</sup>
0.5 h	> 3 years	
1 h	> 6 years	< 1 year <sup>10)</sup>
2 h	> 9 years	> 1 year
4 h	> 10 years	> 3 years
6 h <sup>11)</sup>		> 4 years
12 h		> 7 years
24 h		> 10 years
		> 10 years

---

#### Additional output parameter - Electronics temperature

---

Range	-20 ... +60 °C (-4 ... +140 °F)
Resolution	< 0.1 K
Deviation	±3 K

---

#### Electrical protective measures

---

Protection rating	IP69 acc. to IEC 60529, Type 6X acc. to NEMA <sup>12)</sup>
Altitude above sea level	2000 m (6562 ft)
Protection class	None (autarcic operation)
Pollution degree	4

## 12.2 Radio networks LTE-M and NB-IoT

### LTE-M and NB-IoT

LTE-M (Long Term Evolution for Machines) and NB-IoT (Narrow Band Internet of Things) are extensions of the LTE mobile radio standard to IoT applications. Both enable the wireless connection of mobile, physical objects to the Internet via the mobile network.

You can find more information about the respective mobile phone provider.

## 12.3 Radio networks LoRaWAN - Data transmission

### LoRaWAN

LoRaWAN (Long Range Wide Area Network) is a network protocol for wireless signal transmission to a corresponding gateway. LoRaWAN enables a range of several kilometres outdoors and good building penetration with low power consumption of the transmission module.

In the following, the necessary device-specific details are shown. You can find further information of LoRaWAN on [www.lora-alliance.org](http://www.lora-alliance.org).

<sup>9)</sup> Small measuring intervals with NB-IoT/LTE-M preferably for test measurements

<sup>10)</sup> Small measuring intervals with NB-IoT/LTE-M preferably for test measurements

<sup>11)</sup> Factory default setting

<sup>12)</sup> Specifications apply to housings. With IP69 K for adhesive bonding in addition to the adhesive tape 2-component adhesive, e.g. 3M type 8005, is additionally required



## Data stream, byte order, packet structure

The data are transferred as a byte stream in packets. Each packet is given an identifier at the beginning which defines the meaning of the following bytes.

The byte order corresponds to the Cayenne Low Power Payload (LPP) Guideline as BigEndian.

Packet 2 is transferred as standard. Alternative packets are required if additional characteristic values (error status, position) occur in the sensor. The maximum packet size is 52 bytes in Europe and 11 bytes in the USA with maximum spread factor.

A LoRa standard function additionally transmits a packet counter and the serial number of the LoRa module with every packet.

## Packet structure

Packet							Note
2	3	4	5	6 (USA)	7 (USA)	254	
Number of bytes							
1	1	1	1	1	1	1	Packet identifier
1	1	1	1	1	1		Namur status of the device
4	4	4	4				Measured value as floating point number
1	1	1	1				Unit, measured value
1	1	1	1				Remaining capacity of Lithium cells in %
2	2	2	2				Temperature in °C, resolution ±0,1 K
	8		8	8			Location (GNSS)
		4	4		4		VEGA Device status
1	1	1	1				Angle of inclination to the perpendicular
11	19	15	23	10	6	1	Total

## Packet assignment sensor status

Sensor status	Packet						
	2	3	4	5	6 (USA)	7 (USA)	254
Sensor function error-free	X						
Sensor function error-free plus GPS information		X					
Sensor function error-free plus GPS information (USA)	X				X		
Fault			X				
Error case plus GPS				X			
Fault (USA)	X					X	
Error case plus GPS (USA)	X				X	X	
Sensor in horizontal position			X				
Sensor in horizontal position plus GPS				X			

Sensor status	Packet						
	2	3	4	5	6 (USA)	7 (USA)	254
Sensor in horizontal position (USA)	X					X	
Sensor in horizontal position plus GPS (USA)	X				X	X	
Dummy required							X

### Example data transmission

#### Packet 2, data record 02003FA31F152D2400FA09

Byte 1	Byte 2	Byte 3-6	Byte 7	Byte 8	Byte 9-10	Byte 11
0x02	0x00	0x3FA31F15	0x2D	0x24	0x00FA	0x09
Packet identifier	Namur status	Measured value	Unit	Lithium cells	Temperature	Angle of inclination
2	0 = OK	1.27439	0x2D = 45 = m	36 %	25 °C	9°

#### Packet 5, data record 05047FFFFFFF2D24010442412A784105329B0000565409

Byte 1	Byte 2	Byte 3-6	Byte 7	Byte 8	Byte 9-10	Byte 11-18	Byte 19-22	Byte 23
0x05	0x04	0x7FFFFFFF	0x2D	0x24	0x0104	0x42412A784105329B	0x00005654	0x09
Packet identifier	Namur status	Measured value	Unit	Lithium cells	Temperature	Position	VEGA Device status	Angle of inclination
5	4 = fault	7FFFFFFF = Not a Number	0x2D = 45 = m	36 %	26 °C	48.2915 8.32485	22100	9°

12.4 Dimensions

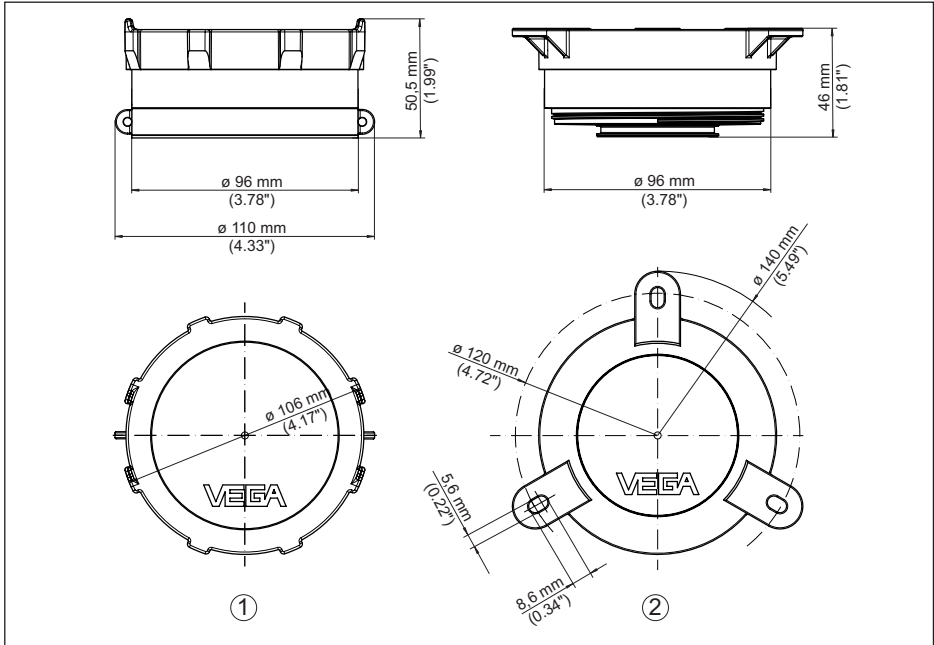

Fig. 18: Dimensions VEGAPULS Air 23

- 1 Version for adhesive and tension belt mounting
- 2 Version for ceiling mounting

## 12.5 Industrial property rights

VEGA product lines are global protected by industrial property rights. Further information see [www.vega.com](http://www.vega.com).

VEGA Produktfamilien sind weltweit geschützt durch gewerbliche Schutzrechte.

Nähere Informationen unter [www.vega.com](http://www.vega.com).

Les lignes de produits VEGA sont globalement protégées par des droits de propriété intellectuelle. Pour plus d'informations, on pourra se référer au site [www.vega.com](http://www.vega.com).

VEGA líneas de productos están protegidas por los derechos en el campo de la propiedad industrial. Para mayor información revise la pagina web [www.vega.com](http://www.vega.com).

Линии продукции фирмы ВЕГА защищаются по всему миру правами на интеллектуальную собственность. Дальнейшую информацию смотрите на сайте [www.vega.com](http://www.vega.com).

VEGA系列产品在全球享有知识产权保护。

进一步信息请参见网站 < [www.vega.com](http://www.vega.com)。

## 12.6 Licensing information for open source software

Open source software components are also used in this device. A documentation of these components with the respective license type, the associated license texts, copyright notes and disclaimers can be found on our homepage.

## 12.7 Trademark

All the brands as well as trade and company names used are property of their lawful proprietor/originator.



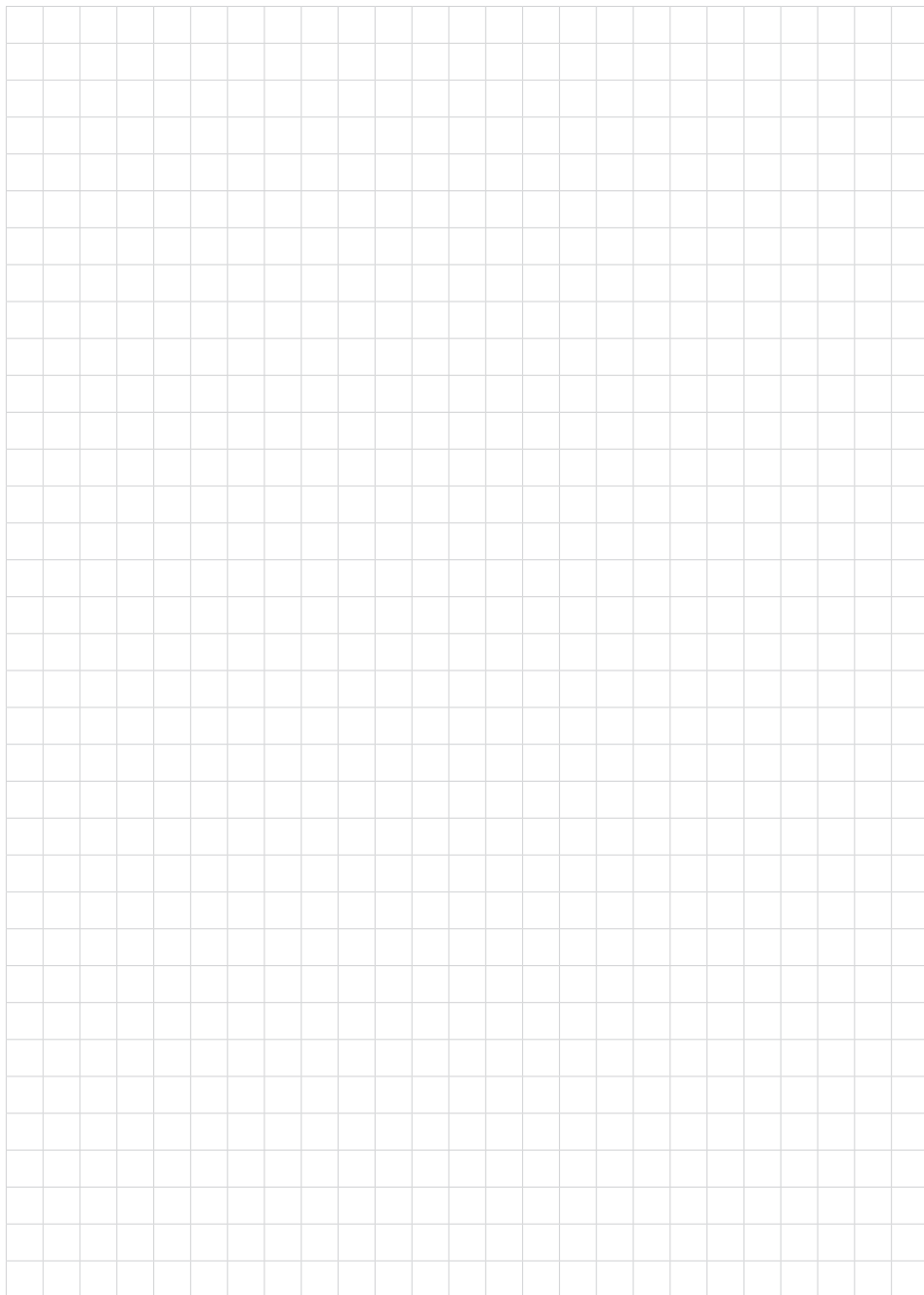



Printing date:

# VEGA

All statements concerning scope of delivery, application, practical use and operating conditions of the sensors and processing systems correspond to the information available at the time of printing.

Subject to change without prior notice

© VEGA Grieshaber KG, Schiltach/Germany 2021



64314-EN-210426

VEGA Grieshaber KG  
Am Hohenstein 113  
77761 Schiltach  
Germany

Phone +49 7836 50-0  
E-mail: [info.de@vega.com](mailto:info.de@vega.com)  
[www.vega.com](http://www.vega.com)